

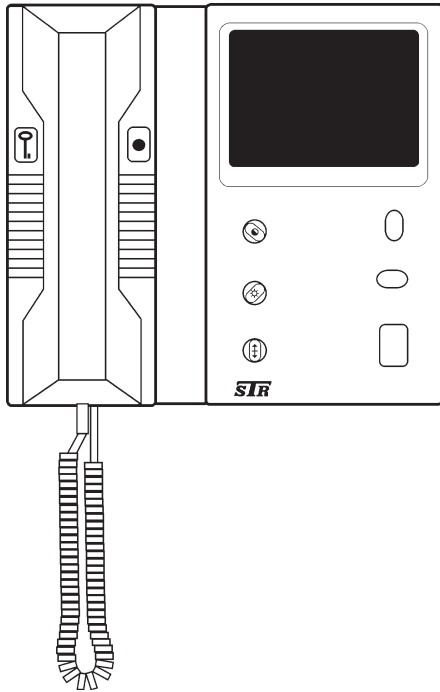

VMH25AWH Series (Apartment Type) Video-Intercom Installation and Use Instructions, used with the VCU6 System Power Supply Unit(s)



**VMH25AWH Video
Monitor Station (shown)**

APPLICATION

The VMH25A series video-intercom system allows any number of VMH25A series inside monitor+handset stations to communicate with one or more door entry stations with (or without) a built-in camera. When used as an apartment video-intercom system, the VMH25AWH can view the caller, speak with the caller, and activate an electric door release (if required).

PROCEDURE

1. Read installation instructions for each unit to determine equipment location and installation method.
2. Install housings and wiring.
3. Install equipment.
4. Check wiring and connect. Observe all local and national electrical codes.
5. Apply power and check system operation.

HOUSING INSTALLATION AND EQUIPMENT LOCATION

INSIDE MONITOR+HANDSET STATION(s)

Locate stations where needed at convenient speaking and viewing height, about 4.5 feet (137 cm) from the finished floor. Unit can be secured directly to the finished wall surface or can be mounted over a single gang electrical 'gem' box or single gang electrical plaster ring.

DOOR ENTRY STATION(s)

Locate door entry station(s) at a convenient speaking location at the building entry location(s). **NOTE: For best picture (video) quality DO NOT POINT CAMERA INTO DIRECT SUNLIGHT!!!**

SYSTEM TRANSFORMER(s)

The T1640 (and T1240) system transformers may be plugged into an accessible source of 117 VAC, preferably within 50' (15 meters) of the VCU6 system power supply unit(s), but no closer than 3 feet (1 meter).

ELECTRIC DOOR OPENER (OPTIONAL)

The DO-001 (or equivalent 12-16VAC type) electric door release is installed in the door jamb in place of the regular door strike plate. It can be electrically operated by the VMH25AWH video monitor+handset station(s).

WIRING

INSIDE HANDSET STATIONS

Run 2 conductor #18AWG (common), 4 conductor #22AWG (common), RG59/U (common) and 1 conductor #22AWG (selective) cable from video monitor+handset to video monitor+handset to the central equipment location (where the VCU6 unit is found). Additional cables may be used to serve other monitors on other risers (lines). Cables may be straight or twisted pair type and may be solid or stranded conductors. Depending upon additional system options and/or functions you may need to run additional wires. Please consult the factory for more information. RG59/U coax cable must be good quality, ALL COPPER, with minimum 95% copper braiding. As with all systems, we recommend running some spare wires, for future use.

Route cable away from AC power wiring, transformers, fluorescent lights, light dimmers or other electrical devices. Protect cable from damage. Shielded cable should

be used if AC interference is a concern, or if cables cannot be run adequately spaced away from any source of electrical interference.

DOOR RELEASE

Run 2 cond. #18 from the door release location to the VCU6 amplifier/power supply. Route away from any station wiring. Note: if wire run is longer than 50 feet (15m), use #16AWG cable.

CONNECTIONS

Before connecting, make certain wires are free from shorts or grounds. Make connections as shown on the enclosed system diagrams, and as indicated below.

NOTE: Please keep in mind that all wiring terminals shown may not be in the actual order in which they appear on the equipment. This is done for clarity of wiring diagram purposes.

TRANSFORMER

1. Connect the 12VAC and 16VAC transformers to the VCU6 amplifier power supply, where indicated. Do not use transformer(s) to power any other device(s).
2. Do not connect transformer primary to 117 VAC until entire installation is complete and all wiring is checked.

DOOR RELEASE

1. Connect 12-16 VAC electric door opener using 2 conductor #18AWG (polarity not important). Route away from any station wiring. Note: if wire run is longer than 50 feet (15m), use #16AWG cable.

FINISH INSTALLATION

1. Install all components. Do not overtighten screws.
2. Connect primary of all transformers to 117 VAC. Observe all local and national electrical codes.

TEST AND CHECKOUT

1. At all remote monitor+handset stations, make certain the handsets are completely hung-up on the handset cradle.
2. Check each monitor+handset unit in the system for operation in accordance with the operating instructions.
3. Check for proper door release function (on systems with door release capability).
4. On systems with multiples entrances, check for proper operation from each calling entrance station.

NOTE: System warranty is void if this system is installed or used in any manner other than described in this manual.

OPERATING INSTRUCTIONS

TO PLACE A CALL TO THE REMOTE MONITOR+HANDSET UNITS:

At the remote door entrance station, depress button (for a few seconds) for apartment you wish to call. This will signal the buzzer (or optional Alphonetone™) signal at the apartment monitor handset, and will cause the video screen to light and display the visitor. The tenant may choose to ignore the caller, or to lift the intercom handset to answer. Tenant may speak to the visitor by simultaneous 2-way (DUPLEX) voice. If tenant is satisfied with identity of caller and wishes to let visitor into the building, tenant shall momentarily depress the door release (KEY) button on the handset, which will electrically activate the door release mechanism. Monitor will time-out automatically after approx. 40 seconds (unless the time-out duration has been changed by the installer/user).

In systems with multiple door entry stations, the system will automatically switch the voice, video and door release functions to the last entry station that placed a call (when used with the appropriate multiple entrance adaptors).

TROUBLESHOOTING

If the system fails to operate as required, review operating instructions again. If the equipment fails to operate as indicated in the instructions, check the following points:

1. **ENTIRE SYSTEM DEAD:** Check for 12VAC and 16VAC at the two (2) transformer secondaries; wiring between transformer and power supply unit(s); connections at main power supply units, 117VAC at transformer primary, and check the (2 amp slo-blo European size) fuse in the VCU6 power supply. If fuse is blown, replace with our model #50T-2A.
2. **NO CALL UP BUZZER AT HANDSET:** Check for approx. 12VAC at terminals 'O' and 'S' on handset, when entry station pushbutton is depressed. Temporarily switch handset with one from a functioning location. Check wiring connections at remote handset. Check that wiring inside handset base is not restricting movement of buzzer clapper; temporarily switch handset to another location that is functioning, and try again. Check that entry station pushbutton is making contact, by shorting out the two (2) wires on the back of the button.
3. **NO PICTURE AT MONITOR:** If screen is NOT LIGHTING UP, check for approximately 16VDC at (+) and (-) terminals on monitor PC board (VH250E or VH250P). Check Brightness and Contrast controls on front of monitor. If screen IS LIGHTING UP but there is no picture, you probably are not getting a video signal

from the camera to the monitor. Starting at camera, check for video signal through coax cable, and through (VDU-4) video distributors (if used). Check for approx. 12VDC power at each VDU-4 video distributor (if used). Check coax connector at camera(s) to make sure it is not shorted or open. Temporarily switch monitor PC board (VH250E or VH250P) with one from a functioning location.

4. **NO VOICE ON SYSTEM:** Check volume control potentiometer on VCU6 amplifier (in both directions; up and down). Check terminals 'T', 'O', and 'M' to handsets. Check speaker/microphone connections at each entry station. Disconnect terminals 'T', 'O' and 'M' on VCU6 system amplifier, and connect a single handset to those terminals. If voice is working, amplifier and entry speaker/microphone are O.K., so check riser wiring. If not amplifier or speaker/microphone could be faulty. Check by replacement.
5. **UNABLE TO RELEASE DOOR STRIKE:** Check wiring to handset terminals '1' and 'O'. Temporarily remove door opener wire from terminal '1' and touch to terminal 'O'. Check operating voltage of door opener matches output from system amplifier. Check wiring (and gauge) to door opener, from amplifier/power supply. When using a magnetic type lock or other 'fail-safe' type door lock, you should use a reversing relay, such as our model# PK407A for each entrance.
6. **HUM OR BUZZ:** Check system wiring installed too close to power wiring or electrical devices or transformers; check transformer(s) installed too close to control equipment (should be at least three (3) feet away). Wiring is being run next to wiring for other systems and/or devices.
7. **MONITORS TIMING OUT TOO QUICKLY:** Check adjusting control potentiometer on VH250E (or VH250P) PC board and adjust as needed from approx. 0 to 180 seconds. Calibration is not exact, so please check timing after re-adjusting. If that doesn't correct the problem, check this out; On the VCU6 amplifier/power supply, there are three (3) sets of (+) and (-) terminals for the Monitors, marked M1+, M1-, M2+, M2-, M3+, M3-. The negative (-) terminals are already jumped together inside the VCU6. Jump the three (3) positive (+) terminals together, as shown on diagrams.
8. **MONITORS DO NOT TIME OUT AT ALL:** Check for shorts and/or grounds on system. Temporarily switch monitor with one from a functioning location. Check that entry station pushbutton is not stuck or shorted. Temporarily switch monitor PC board (VH250E or VH250P) with one from a functioning location.

PLEASE NOTE: If these checkpoints fail to indicate the problem, there may be an equipment or wiring fault. Please contact the factory or a qualified service representative.

VMH25A COMPONENT LISTING

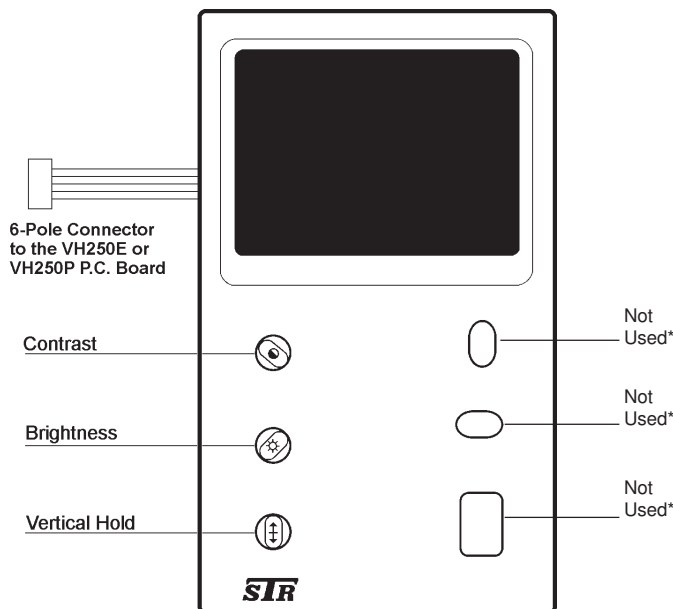

* These buttons and cap blanks are used on other systems and do not apply to this configuration

TYPICAL REPLACEMENT PARTS

- Model# VCU6:** Amplifier/Power Supply unit. One (1) required for each 30 (or less) monitors.
- Model# VDU-4:** Four (4) output Video Distributor. One (1) required for each four (4) (or less) video outputs to monitor risers/lines.
- Model# TU1007A:** Multiple Entrance audio switching adaptor. Used to switch the voice (and door release) to the calling entrance. One (1) required for 2 entrances, two (2) required for 3-4 entrances, three (3) required for 5-6 entrances, and four (4) required for 7-8 entrances. Used on systems with more than one (1) entrance station.
- Model# DPS-2 (TUV2):** Multiple Entrance video switching adaptor. Used (in addition to the TU1007A) to switch the video to the calling entrance. One (1) required for 2 entrances, two (2) required for 3-4 entrances, three (3) required for 5-6 entrances, and four (4) required for 7-8 entrances. Used on systems with more than one (1) entrance station, where video switching is required.

General Monitor Mounting and Wiring Information

Note: There are Black and Red pigtail wires coming from terminals 'O' and 'LL' on the VH250E (or VH250P) P.C. Board. The Black 'O' wire must jump to terminal 'O' on the handset and the Red 'LL' wire must jump to terminal 'S' on the handset or the monitor will not activate when the handset is signalled from the entrance station(s).

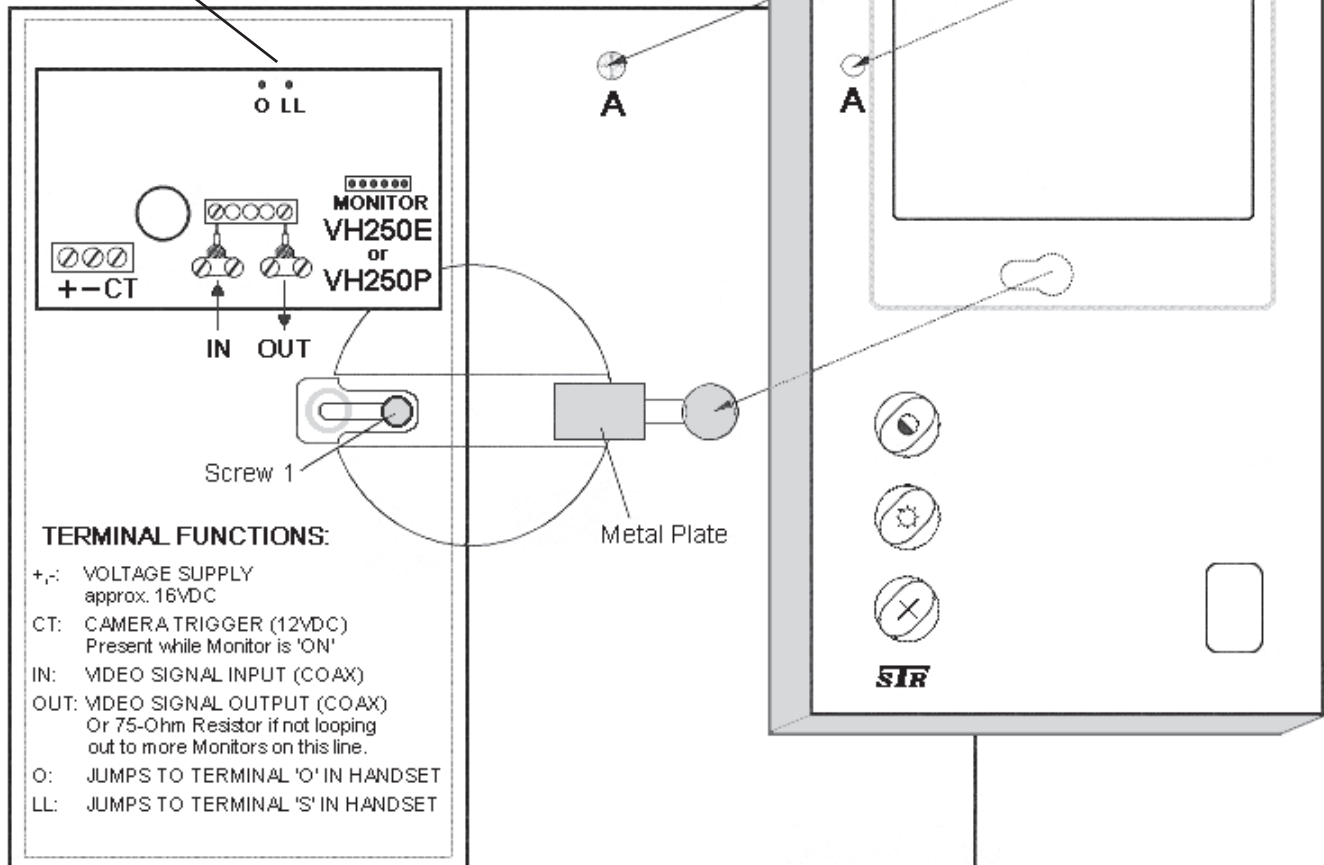

Taking the monitor off of the base:

1. Carefully remove the 6-pole plug-in connector from the VH250E / VH250P board making sure not to dislodge wires.
2. Loosen "Screw 1" and slide it to the Right.
3. Pull the lower part of the monitor about 1-2cm away from the main base ①
4. Slide the Monitor 'up' until it comes free ②

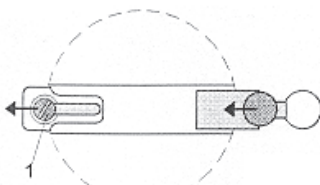

Slide "Screw 1" to the left and tighten screw down: MONITOR IS LOCKED DOWN

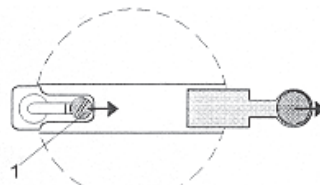

Loosen "Screw 1" and slide it to the right. MONITOR CAN NOW BE REMOVED FROM HOUSING

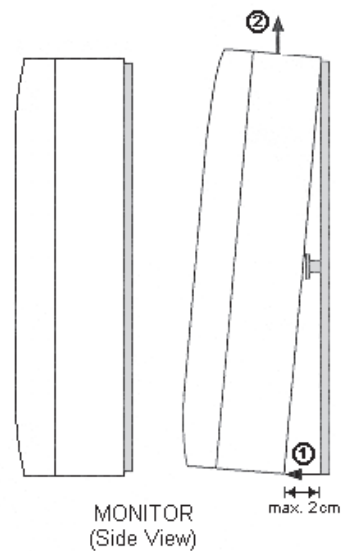

TYPICAL WIRING DIAGRAM FOR DUAL ENTRANCE SYSTEM WITH S.T.R.™ STYLE CAMERA AND ONE (1) VIDEO RISER (NO VIDEO DISTRIBUTORS)

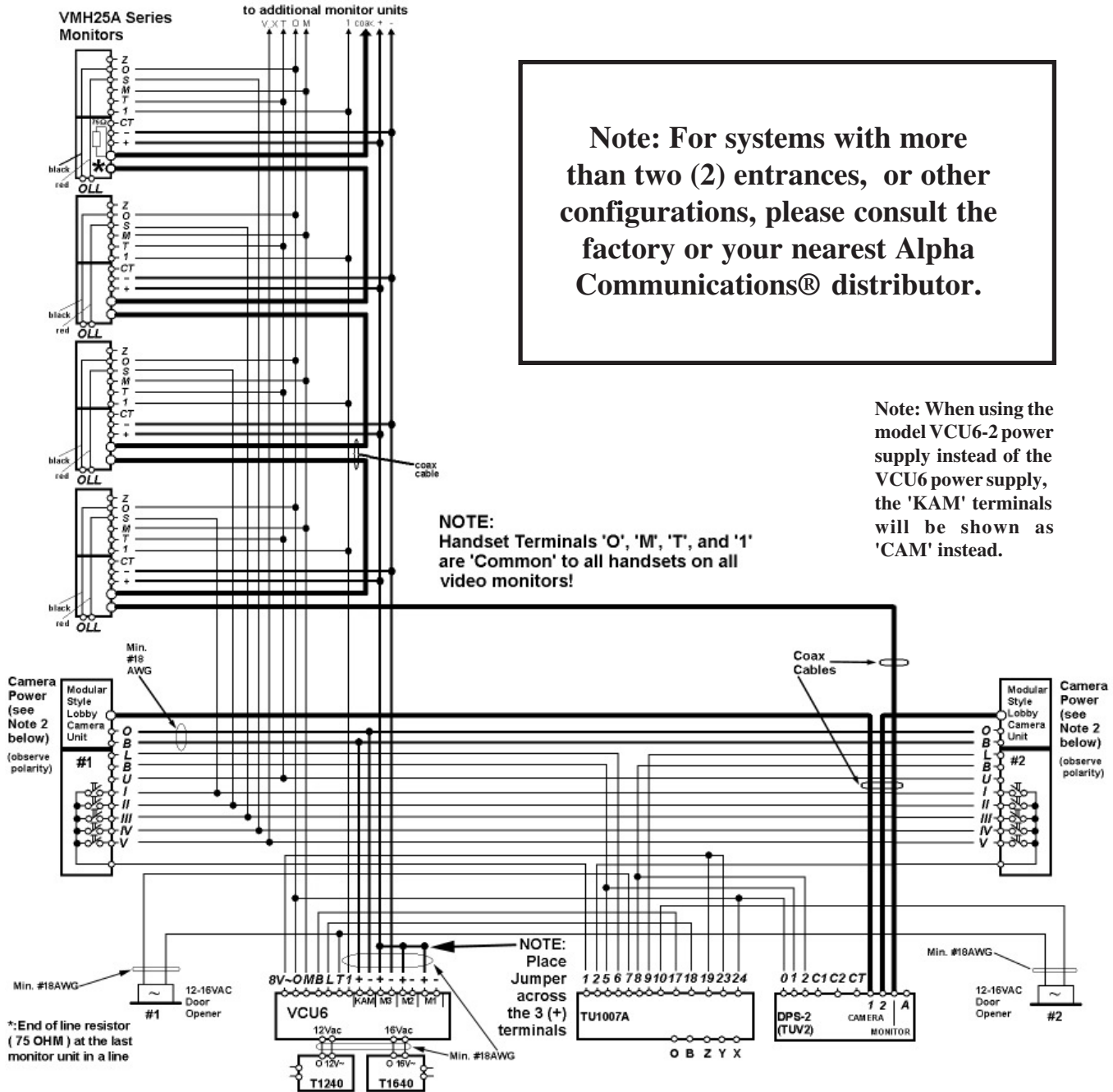

Note: For systems with more than two (2) entrances, or other configurations, please consult the factory or your nearest Alpha Communications® distributor.

Note: When using the model VCU6-2 power supply instead of the VCU6 power supply, the 'KAM' terminals will be shown as 'CAM' instead.

NOTE:
Handset Terminals 'O', 'M', 'T', and '1' are 'Common' to all handsets on all video monitors!

*:End of line resistor (75 OHM) at the last monitor unit in a line

Notes:

1. All wiring is #22AWG unless shown otherwise.
2. When using a PINHOLE type camera, instead of the standard S.T.R.™ type camera, see the special camera installation and connection instructions found on page 8, and do not power as shown above.
3. DO NOT CONNECT MORE THAN 10 MONITORS PER RISER/LINE.
4. Observe all local and national electrical and building codes.
5. All terminals connections shown may not be in the order that they appear on the equipment.

**IF YOU ARE USING A PINHOLE STYLE CAMERA(s)
IN PLACE OF THE STANDARD S.T.R.™ STYLE CAMERA(s)
CONNECT THE CAMERA(s) AS SHOWN ON THIS DIAGRAM,
AND NOT AS SHOWN ON THE PROCEEDING PAGES.**

**THESE CAMERAS ARE TYPICALLY USED WITH THE
NATURAL ANODIZED ALUMINUM,
STAINLESS STEEL AND POLISHED BRASS PANELS.**

**THESE CAMERAS ARE POWERED BY THEIR OWN
PLUG-IN POWER SUPPLY, WHICH IS SUPPLIED
WITH EACH CAMERA.**

POLARITY MUST BE OBSERVED!!

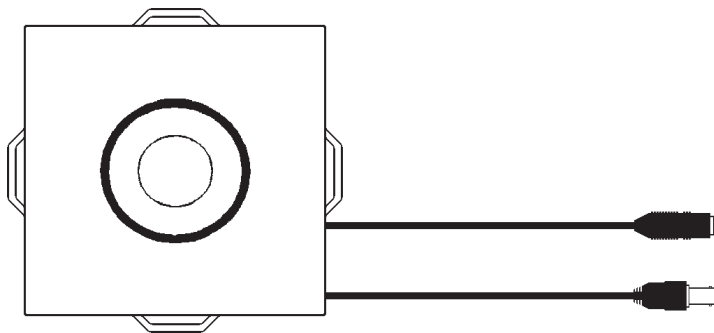

**Mini (Pinhole) Camera
(front view)**

Plug-In Connector for
Model **SS12P** 12VDC
Power Supply (included)

Twist-On (BNC) Connector
for RG59/U Coaxial Cable
(use model **CONN360** or
equivalent connector)

IMPORTANT INFORMATION AND WARNING:

THESE ARE LOW VOLTAGE DC POWERED CAMERAS AND THEY ARE POLARITY SENSITIVE.

THE POLARITY IS AUTOMATICALLY CORRECT WHEN THE POWER SUPPLY MODULE IS PLUGGED DIRECTLY INTO THE CAMERA USING THE FACTORY INSTALLED CONNECTORS. IF IT IS NECESSARY TO EXTEND THE DISTANCE BETWEEN THE POWER MODULE AND THE CAMERA, CUT AND SPLICE THE WIRE ON THE POWER MODULE ONLY. IF IT IS NECESSARY TO REMOVE THE POWER CONNECTOR OR CUT AND EXTEND THE POWER CABLE, IT IS VERY IMPORTANT TO MAKE SURE THAT THE POLARITY IS CORRECT BEFORE POWER IS SUPPLIED TO THE CAMERA. USE A METER TO CHECK THE POLARITY OF THE NEWLY SPLICED CABLE BEFORE CONNECTING IT TO THE CAMERA.

THE CENTER PIN MUST BE POSITIVE!

USE ONLY THE SUPPLIED POWER SUPPLY! POWER SUPPLY IS FOR INDOOR USE ONLY.

DO NOT REMOVE THE SERIAL NO. STICKER, AS THIS WILL VOID THE WARRANTY.

ALPHA COMMUNICATIONS® • 42 Central Drive • Farmingdale NY 11735-1202
TOLL-FREE TECHNICAL LINE 1-800-666-4800 • Phone: 631-777-5500 • Fax: 631-777-5599
WEBSITE: www.AlphaCommunications.com • EMAIL: info@alphacommunications.com